

VISTA B

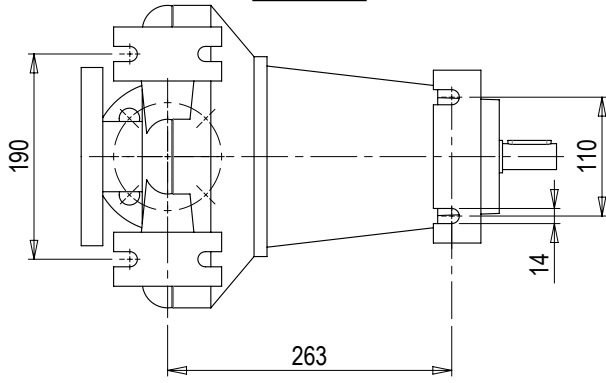

SEZ. A-A  
SCALA: 1:1

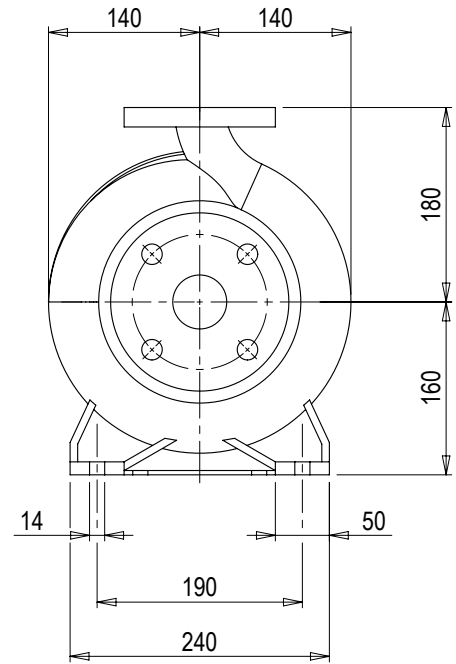
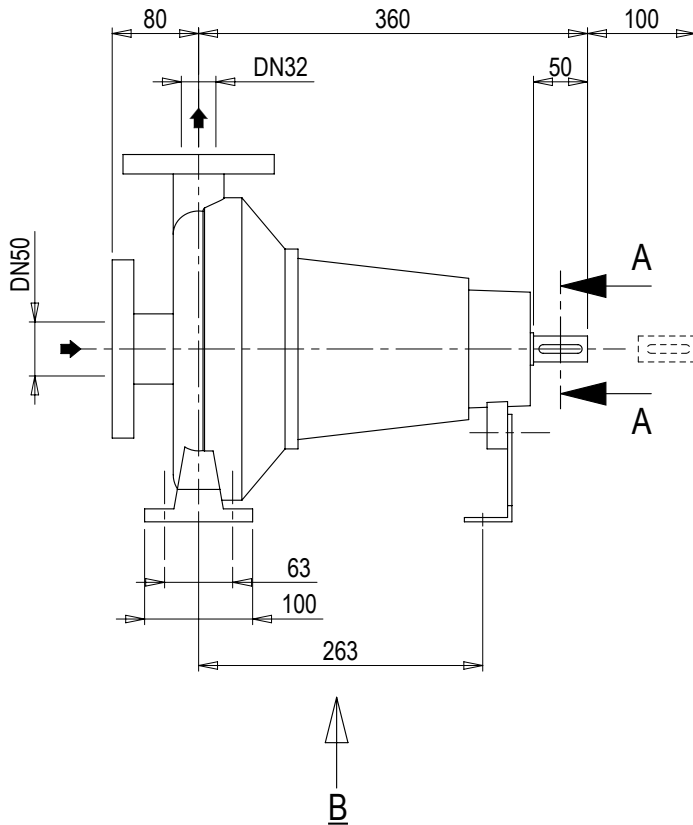
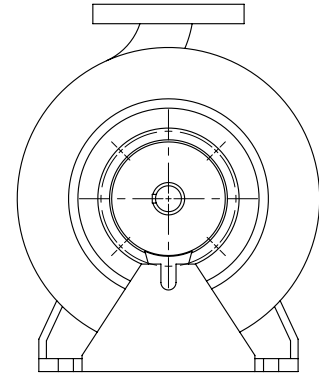
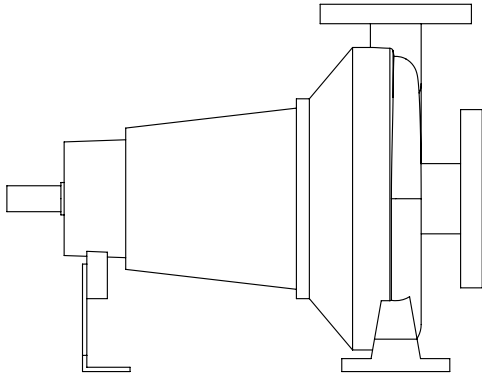
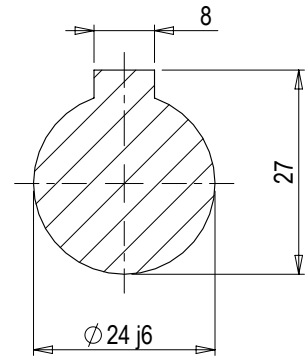

Dimensioni in mm Dimensions in mm		Dipartimento: Department:	<b>Z13</b>	N° Disegno / Drw N°:	Vers:	Foglio / Sheet:
Scala / Scale: 1:7	Data / Date: 30.05.2023	Disegnato / Drawn: DS00291	Approvato / Checked:	<b>10017984</b>	<b>00</b>	<b>1/1</b>